

H10

Tabouret pieds bois

La chaise H10, accueillante et configurable à l'infini.



Fabrication

100% France

Utilisation

Intérieure

Entretien

Frotter avec un chiffon doux légèrement humide.
Laisser sécher.

Modèle H10 – Tabouret pieds bois
Finitions pieds bois et assise hêtre.

Spécifications

Assises

Bois moulé ép. 10mm

	Hêtre
	Black beech
	Blue beech
	Brown beech
	Cherry beech
	Green beech
	Pink beech
	Sand beech
	Yellow beech

Logistique

Poids : 6 kg









Livré monté.

Délais 5 semaines.

Dim. packaging carton :
600X540X1070 mm

Pieds

Bois massif

	Hêtre
	Black beech
	Blue beech
	Brown beech
	Cherry beech
	Green beech
	Pink beech
	Sand beech
	Yellow beech

Dimensions

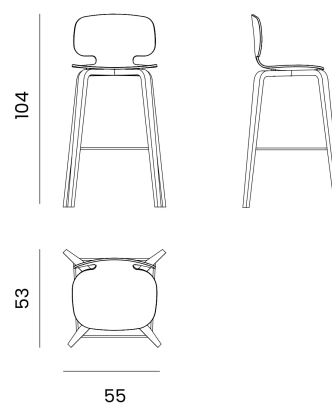

lcf

la chaise française

24 rue Saint-Bernard

10310 Clairvaux, FRANCE

Contact

jeancharles@lachaisefrançaise.fr

Tel +33 (0) 7 72 66 55 93